





Model Code: MOA360

Included Accessories

 6020	 UMD	 ICM8

Optional Accessories

 CBB328	 CNA-3-845	 COA53
 DR007	 DTA27	 CBF261

Dimensions

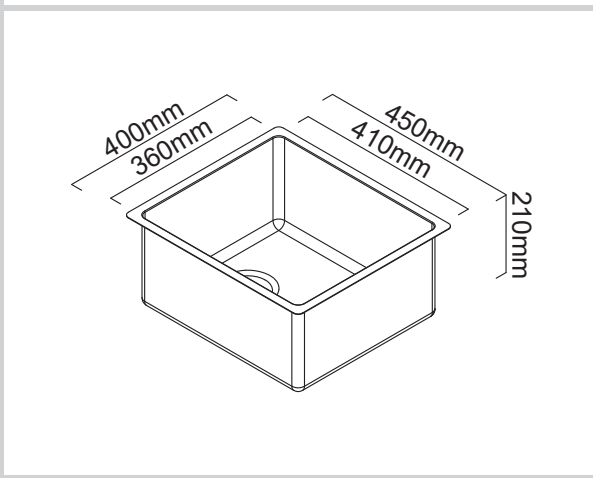

Specifications

Description	Single Bowl, Inset/Undermount Sink
Overall Sink Size	400mm x 450mm x 210mm deep
Bowl Dimensions	360mm x 410mm x 210mm deep
Drainer Length	N/A
Technic	Fabrication
Material	1 mm Stainless steel SUS304

Installation

Fixings	Inset & Undermount clips supplied
Template	N/A
Min Cabinet Size	500mm
Waste Holes	1 x 90mm round Compatible with waste disposal

Plumbing

Waste Fittings	1 x (90mm x 2") basket waste included
----------------	---------------------------------------

Packaging

Carton Type	Eco packaging & Individual carton
Gross Weight	6.8Kg
Carton Size	475mm x 330mm x 550mm
Pack QTY	1

SURFACE FINISH



WASTE KIT

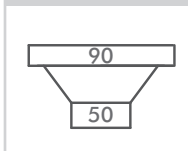

MATERIAL



INSTALLATION OPTIONS

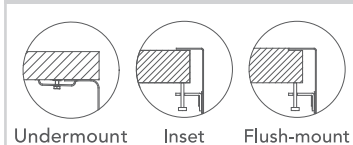

PROFILE

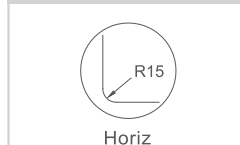

Abey are Australia's leaders in sinkware, designing and manufacturing to the world's highest quality specifications as well as sourcing and bringing you Europe's very best, leading edge designs – practical, affordable, inspirational, stylish, timeless or cutting edge. When you buy an Abey stainless steel sink you receive the highest quality and a 25 year warranty. Abey and the manufacturer are continually seeking ways to improve the design specifications, aesthetic and production techniques of the products. As a result, alterations to the specifications and dimensions of the products and designs occur continually.