

# FS9606AS-1

|                                  |               |
|----------------------------------|---------------|
| Cooker size                      | 90x60 cm      |
| N. of cavities with energy label | 1             |
| Cavity heat source               | ELECTRICITY   |
| Hob type                         | Gas           |
| Type of main oven                | Thermoseal    |
| Cleaning system main oven        | Vapour Clean  |
| EAN code                         | 8017709310615 |



## Aesthetics









|                                |                      |                            |                          |
|--------------------------------|----------------------|----------------------------|--------------------------|
| <b>Design</b>                  | Standard             | <b>Controls colour</b>     | Stainless steel          |
| <b>Command panel finish</b>    | Enamelled metal      | <b>No. of controls</b>     | 7                        |
| <b>Aesthetic</b>               | Classic              | <b>Serigraphy colour</b>   | Silver                   |
| <b>Logo</b>                    | Assembled            | <b>Display</b>             | Touch                    |
| <b>Colour</b>                  | Anthracite           | <b>Door</b>                | With 2 horizontal strips |
| <b>Logo position</b>           | Facia below the oven | <b>Glass type</b>          | eclipse                  |
| <b>Upstand</b>                 | Yes                  | <b>Handle</b>              | Smeg Classic             |
| <b>Serie</b>                   | Concerto             | <b>Handle Colour</b>       | Brushed stainless steel  |
| <b>Hob colour</b>              | Stainless steel      | <b>Storage compartment</b> | Door                     |
| <b>Type of pan stands</b>      | Cast Iron            | <b>Feet</b>                | Silver                   |
| <b>Type of control setting</b> | Control knobs        | <b>Plinth</b>              | Stainless steel          |
| <b>Control knobs</b>           | Smeg Classic         |                            |                          |

## Programs / Functions

No. of cooking functions 6

Traditional cooking functions

|  |   |   |
|--|---|---|
|  Static      |  Fan assisted      |  Circulaire          |
|  Large grill |  Fan grill (large) |  Fan assisted bottom |

### Cleaning functions

|   |
|---|
|  Vapour Clean |
|---|

## Hob technical features



**Total no. of cook zones** 5

Front left - Gas - Rapid - 2.90 kW

Rear left - Gas - Semi Rapid - 1.80 kW

Central - Gas - UR - 4.00 kW

Rear right - Gas - Semi Rapid - 1.80 kW

Front right - Gas - AUX - 1.00 kW

**Type of gas burners** Standard

**Automatic electronic ignition** Yes

**Gas safety valves** Yes

**Burner caps** Matte black enamelled

## Main Oven Technical Features



**No. of lights** 2

**Fan number** 2

**Net volume of the cavity** 115 l

**Gross volume, 1st cavity** 126 l

**Cavity material** Ever Clean enamel

**No. of shelves** 5

**Type of shelves** Metal racks

**Light type** Halogen

**Light Power** 40 W

**Cooking time setting** Stop

**Light when oven door is open** Yes

**Door opening** Flap down

**Removable door** Yes

**Full glass inner door** Yes

**Total no. of door glasses** 3

**No. of thermo-reflective door glasses** 2

**Safety Thermostat** Yes

**Cooling system** Tangential

**Usable cavity space dimensions (HxWxD)** 371x724x418 mm

**Temperature control** Electro-mechanical

**Lower heating element power** 1700 W

**Upper heating element - Power** 1200 W

**Grill element** 1700 W

**Large grill - Power** 2900 W

**Circular heating element - Power** 2 x 1550 W

**Grill type** Electric

## Options Main Oven

**Timer** Yes

**End of cooking acoustic alarm** Yes

**Minimum Temperature** 50 °C

**Maximum temperature** 260 °C

## Accessories included for Main Oven & Hob



**Rack with back and side stop** 1

**Grill mesh** 1

|                |   |  |   |
|----------------|---|--|---|
| 20mm deep tray | 1 | Telescopic Guide rails, partial Extraction | 1 |
| 40mm deep tray | 1 |  |   |

## Electrical Connection

|                                  |                   |                           |               |
|----------------------------------|-------------------|---------------------------|---------------|
| Electrical connection rating     | 3200 W            | Power supply cable length | 120 cm        |
| Current                          | 14 A              | Frequency                 | 50/60 Hz      |
| Voltage                          | 220-240 V         | Terminal block            | 3 poles       |
| Type of electric cable installed | Yes, Single phase | Plug                      | (I) Australia |

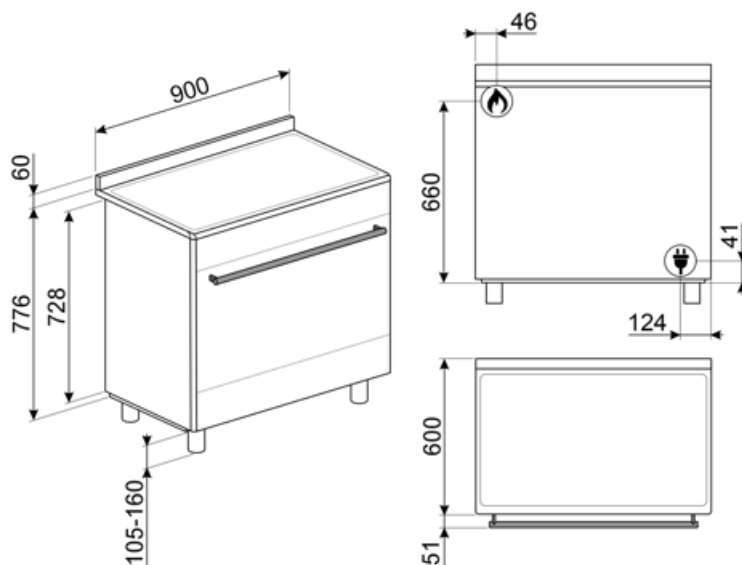

## Compatible Accessories

### AIRFRY9

Air fryer rack AIRFRY . Ideal for recreating traditional frying in the oven, but with fewer calories and less fat. It allows you to cook quickly and simply dishes such as French fries, fried vegetables and fish, ensuring perfect browning and crispiness.



### BN920

Enamelled tray 90cm cavity, 20mm deep



### GTP

\*\*Partially extractable telescopic guides (1 level)\*\* Extraction: 300 mm Material: Stainless steel AISI 430 polished



### KIT600SNL-9

Cover strip for hob back side, suitable for 90 cm Concerto cookers



### KIT90X9-1

Splash back, 90x60 cm, stainless steel, for Concerto cookers



### BBQ9

teflon-coated aluminum grid for 90 cm cavity



### BN940

Enamelled tray 90 cm, 40 mm deep



### GTT

\*\*Totally extractable telescopic guides (1 level)\*\* Extraction: 433 mm Material: Stainless steel AISI 430 polished



### KIT90N9

Splashback 90 cm, black, for BU & BM cookers



### KITH95

Height extension kit (950 mm), stainless steel



### KITPDQ

Height reduction feet (850 mm), stainless steel, for cookers



### SFLK1

Child lock



### PALPZ

Pizza shovel with fold away handle width: 315mm length : 325mm







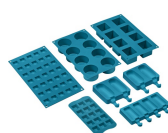













### SMOLD

Set of 7 silicone moulds for ice creams, ice lollies, pralines, ice cubes or to portion food. Usable from -60°C to +230°C



## Symbols glossary

|  |  |
|--|--|
|  <p>Heavy duty cast iron pan stands: for maximum stability and strength.</p>   |  <p>Installation in column: Installation in column</p>  |
|  <p>Air cooling system: to ensure a safe surface temperatures.</p>   |  <p>Triple glazed doors: Number of glazed doors.</p>  |
|  <p>Enamel interior: The enamel interior of all Smeg ovens have a special antacid lining which helps keep the interior clean by reducing the amount of cooking grease adhering to it.</p>  |  <p>Fan assisted base: the mix of fan and lower heating element alone allows to finish cooking foods already cooked on the surface but not internally more quickly. This system is recommended to finish cooking foods that are already well cooked on the surface, but not internally, which therefore require a moderate higher heat. Ideal for any type of food.</p> |
|  <p>Fan with upper and lower elements: The elements combined with the fan aim to provide more uniform heat, a similar method to conventional cooking, so pre-heat is required. Most suitable for items requiring slow cooking methods.</p>   |  <p>Upper and lower element only: a traditional cooking method best suited for single items located in the centre of the oven. the top pf the oven will always be hottest. Ideal for roast, fruit cakes, bread etc.</p>   |
|  <p>Circulaire: The combination of the fan and circular element around it gives a hot air cooking method. This provides many benefits including no preheat if cook time is more than 20 minutes, no flavour transfer when cooking different foods at the same time, less energy, and shorter cook times. Good for all types of food.</p>   |  <p>Grill element: Using of grill gives excellent results when cooking meat of medium and small portions, especially when combined with a rotisserie (where possible). Also ideal for cooking sausages and bacon.</p>   |
|  <p>Fan with grill element: The fan reduces the fierce heat from the grill, providing an excellent method of grilling various foods, chops, steaks, sausages etc. giving even browning and heat distribution, without drying out the food. The top two levels recommended for use, and the lower part of the oven can be used to keep items warm at the same time, an excellent facility when cooking a grilled breakfast. Half grill (centre portion only) is ideal for small quantities of food.</p> |  <p>All glass inner door: All glass inner door, a single flat surface which is simple to keep clean.</p>  |
|  <p>Side lights: Two opposing side lights increase visibility inside the oven.</p>   |  <p>Automatic opening: some models have Automatic opening door when the cycle is finished which is a perfect solution for handle-less kitchen units as no handle is needed. For safety reasons, the door locks automatically when the machine is in use to avoid it being opened inadvertently.</p>   |
|  <p>The oven cavity has 5 different cooking levels.</p>  |  <p>Telescopic rails: allow you to pull out the dish and check it without having to remove it from the oven entirely.</p>   |
|  <p>Ultra rapid burners: Powerful ultra rapid burners offer up to 5kw of power.</p>  |  <p>Vapour Clean: a simple cleaning function using steam to loosen deposits in the oven cavity.</p>   |



The capacity indicates the amount of usable space in the oven cavity in litres.



4.3 inch display with LED technology, usability with knobs + 3 touch keys



Knobs control