

# TRA4110P

Cooker size	110x60 cm
N. of cavities with energy label	3
Cavity heat source	ELECTRICITY
Hob type	Gas
Type of main oven	Thermoseal
Type of second oven	Fan assisted
Cleaning system main oven	Vapour Clean
EAN code	8017709171612



## Aesthetics



<b>Design</b>	Victoria	<b>Control knobs</b>	Smeg Victoria
<b>Command panel finish</b>	Enamelled metal	<b>Controls colour</b>	Stainless steel
<b>Aesthetic</b>	Victoria	<b>No. of controls</b>	12
<b>Logo</b>	assembled 50's	<b>Serigraphy colour</b>	Black
<b>Colour</b>	Cream	<b>Display</b>	electronic 5 buttons
<b>Logo position</b>	Upstand	<b>Door</b>	With frame
<b>Finishing</b>	Glossy	<b>Glass type</b>	Black
<b>Upstand</b>	Yes	<b>Handle</b>	Smeg Victoria
<b>Hob colour</b>	Black enamel	<b>Handle Colour</b>	Brushed stainless steel
<b>Type of pan stands</b>	Cast Iron	<b>Storage compartment</b>	Drawer
<b>Type of control setting</b>	Control knobs	<b>Plinth</b>	Anthracite

## Programs / Functions

No. of cooking functions 5

Traditional cooking functions

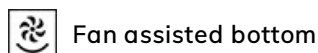
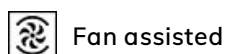
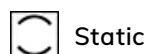

Other functions



### Cleaning functions

 Vapour Clean

## Programs / Functions Auxiliary Oven

Cooking functions cavity 2

Bottom element + fan

5



Bottom element + Upper element



Traditional cooking functions, cavity 2



Static



Fan assisted



Circulaire



Eco



Fan-assisted bottom

Defrost



Vapour Clean



Other functions cavity 2

## Programs / Functions Third Oven

No. of functions third oven

1

Oven light



Full grill



## Hob technical features

**UR**

**Total no. of cook zones** 7

Front right - Gas - Semi Rapid - 1.80 kW

Rear right - Gas - Semi Rapid - 1.60 (BBQ) kW

Front centre - Gas - Rapid - 2.90 kW

Rear centre - Gas - AUX - 1.40 - 0.80 kW

Rear left - Gas - Rapid - 2.90 kW

Front left - Gas - AUX - 1.00 kW

Left - Gas - 2UR (dual) - 4.20 kW

**Type of gas burners** Standard

**Gas safety valves** Yes

**Automatic electronic ignition** Yes

**Burner caps**

Matte black enamelled

## Main Oven Technical Features



<b>No. of lights</b>	1	<b>Total no. of door glasses</b>	3
<b>Net volume of the cavity</b>	63 l	<b>No. of thermo-reflective door glasses</b>	1
<b>Gross volume, 1st cavity</b>	68 l	<b>Safety Thermostat</b>	Yes
<b>Cavity material</b>	Ever Clean enamel	<b>Cooling system</b>	Tangential
<b>No. of shelves</b>	4	<b>Usable cavity space dimensions (HxWxD)</b>	316x444x425 mm
<b>Type of shelves</b>	Metal racks	<b>Temperature control</b>	Electro-mechanical
<b>Light type</b>	Halogen	<b>Lower heating element power</b>	1200 W
<b>Light Power</b>	40 W	<b>Upper heating element - Power</b>	1000 W
<b>Cooking time setting</b>	Start and Stop	<b>Grill element</b>	1700 W
<b>Door opening</b>	Side opening	<b>Large grill - Power</b>	2700 W
<b>Removable door</b>	Yes	<b>Circular heating element - Power</b>	2700 W
<b>Full glass inner door</b>	Yes	<b>Grill type</b>	Electric
<b>Removable inner door</b>	Yes		

## Options Main Oven

<b>Timer</b>	Yes	<b>Minimum Temperature</b>	50 °C
<b>End of cooking acoustic alarm</b>	Yes	<b>Maximum temperature</b>	260 °C

## Second Oven Technical Features



<b>Net volume of the second cavity</b>	63 l	<b>No. total door glasses</b>	3
<b>Gross volume, 2nd cavity</b>	68 l	<b>No. thermo-reflective door glasses</b>	1
<b>Cavity material</b>	Ever Clean enamel	<b>Safety Thermostat</b>	Yes
<b>No. of shelves</b>	4	<b>Cooling system</b>	Tangential
<b>Type of shelves</b>	Metal racks	<b>Usable cavity space dimensions (HxWxD)</b>	316x444x425 mm
<b>No. of lights</b>	1	<b>Temperature control</b>	Electro-mechanical
<b>Light type</b>	Halogen	<b>Lower heating element - power</b>	1200 W
<b>Light Power</b>	40 W	<b>Upper heating element - Power</b>	1000 W
<b>Door opening</b>	Side opening	<b>Grill element - power</b>	1700 W
<b>Removable door</b>	Yes	<b>Large grill - Power</b>	2700 W
<b>Full glass inner door</b>	Yes	<b>Grill type</b>	Electric
<b>Removable inner door</b>	Yes	<b>Tilting grill</b>	Yes

## Options Auxiliary Oven

<b>Minimum Temperature</b>	50 °C	<b>Maximum temperature</b>	260 °C
----------------------------	-------	----------------------------	--------

## Third Oven Technical Features



<b>Net volume, 3rd cavity</b>	36 l	<b>Removable inner door</b>	Yes
<b>Gross volume, 3rd cavity</b>	41 l	<b>No. total door glasses</b>	3
<b>Cavity material</b>	Ever Clean enamel	<b>No. of thermo-reflective door glasses</b>	1
<b>No. of shelves</b>	2	<b>Safety Thermostat</b>	Yes
<b>Type of shelves</b>	Metal racks	<b>Cooling system</b>	Tangential
<b>No. of lights</b>	1	<b>Usable cavity space dimensions (HxWxD)</b>	169x440x443 mm
<b>Light type</b>	Incandescent	<b>Temperature control</b>	Electro-mechanical
<b>Light Power</b>	25 W	<b>Large grill - Power</b>	2700 W
<b>Door opening</b>	Flap down	<b>Grill type</b>	Electric
<b>Removable door</b>	Yes	<b>Tilting grill</b>	Yes
<b>Full glass inner door</b>	Yes		

## Options Third Oven

<b>Minimum Temperature</b>	50 °C	<b>Maximum temperature</b>	260 °C
----------------------------	-------	----------------------------	--------

## Accessories included for Main Oven & Hob



<b>Cast iron wok support</b>	1	<b>40mm deep tray</b>	1
<b>Teppanyaki</b>	1	<b>Grill mesh</b>	1
<b>Rack with back and side stop</b>	2	<b>Telescopic Guide rails, partial Extraction</b>	1

## Accessories included for Secondary Oven



<b>Rack with back and side stop</b>	2	<b>Grill mesh</b>	1
<b>40mm deep tray</b>	1	<b>Telescopic Guide rails, partial Extraction</b>	1

## Accessories included for Third Oven

<b>Rack with back and side stop</b>	1	<b>40mm deep tray</b>	1
-------------------------------------	---	-----------------------	---

## Electrical Connection

<b>Electrical connection rating</b>	8700 W	<b>Type of electric cable</b>	Yes, Double and Three Phase
<b>Current</b>	38 A	<b>Frequency</b>	50/60 Hz
<b>Voltage</b>	220-240 V	<b>Terminal block</b>	5 poles
<b>Voltage 2 (V)</b>	380-415 V	<b>Plug</b>	(I) Australia

Type of electric cable installed Yes, Single phase

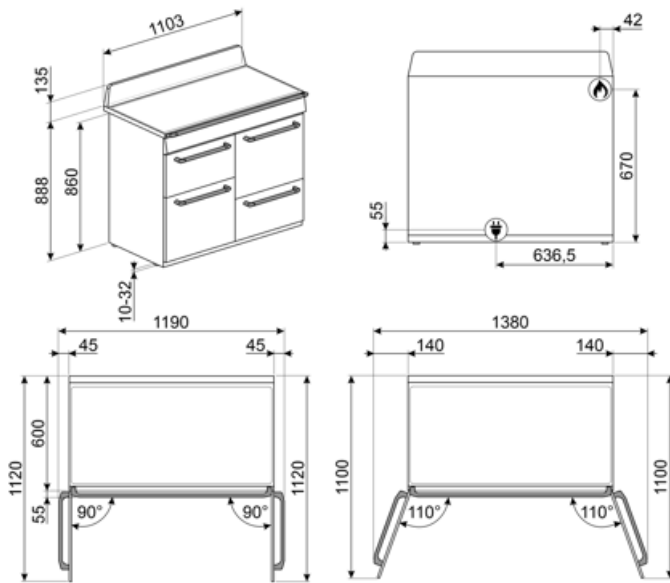

## Compatible Accessories

### AIRFRY

Air fryer rack AIRFRY. Ideal for recreating traditional frying in the oven, but with fewer calories and less fat. It allows you to cook quickly and simply dishes such as French fries, fried vegetables and fish, ensuring perfect browning and crispiness.



### BBQ

Double sided plate BBQ. Suitable for recreating succulent and crispy dishes in the oven with the typical taste of grilled cooking. The ribbed side is particularly suitable for meats and cheeses. The smooth side for fish, seafood and vegetables.



### BN640

Enamelled tray, 40mm deep



### GTP

\*\*Partially extractable telescopic guides (1 level)\*\* Extraction: 300 mm Material: Stainless steel AISI 430 polished



### KIT1TR41N

Splashback 110x75 cm suitable for TR4110 Victoria cookers, black



### KITH4110

Height extension kit (950 mm), suitable for TR4110 cookers



### PALPZ

Pizza shovel with fold away handle width: 315mm length : 325mm



### SMOLD

Set of 7 silicone moulds for ice creams, ice lollies, pralines, ice cubes or to portion food. Usable from -60°C to +230°C

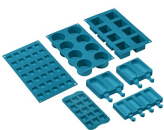

### AIRFRY2

Air fryer tray. Ideal for recreating traditional frying in the oven, but with fewer calories and less fat. It allows you to cook quickly and simply dishes such as French fries, fried vegetables and fish, ensuring perfect browning and crispiness.



### BN620-1

Enamelled tray, 20mm deep



### BNP608T

Teflon-coated tray, 8mm depth, to be placed on the grid



### GTT

\*\*Totally extractable telescopic guides (1 level)\*\* Extraction: 433 mm Material: Stainless steel AISI 430 polished



### KIT600TR4110

Cover strip for hob back side, suitable for TR4110 Victoria cookers



### KITP65TR41

Depth extension kit (650 mm), suitable for TR4110 cookers































### SFLK1

Child lock



## Symbols glossary

 <p>Heavy duty cast iron pan stands: for maximum stability and strength.</p>	 <p>Installation in column: Installation in column</p>
 <p>Air cooling system: to ensure a safe surface temperatures.</p>	 <p>With the switch on this symbol, no heating is possible even if the thermostat is turned.</p>
 <p>Triple glazed doors: Number of glazed doors.</p>	 <p>Enamel interior: The enamel interior of all Smeg ovens have a special antacid lining which helps keep the interior clean by reducing the amount of cooking grease adhering to it.</p>
 <p>Fan assisted base: the mix of fan and lower heating element alone allows to finish cooking foods already cooked on the surface but not internally more quickly. This system is recommended to finish cooking foods that are already well cooked on the surface, but not internally, which therefore require a moderate higher heat. Ideal for any type of food.</p>	 <p>Fan with upper and lower elements: The elements combined with the fan aim to provide more uniform heat, a similar method to conventional cooking, so pre-heat is required. Most suitable for items requiring slow cooking methods.</p>
 <p>Upper and lower element only: a traditional cooking method best suited for single items located in the centre of the oven. the top pf the oven will always be hottest. Ideal for roast, fruit cakes, bread etc.</p>	 <p>Upper and lower element only: a traditional cooking method best suited for single items located in the centre of the oven. the top pf the oven will always be hottest. Ideal for roast, fruit cakes, bread etc.</p>
 <p>Lower heating element only: This function is ideal for foods that require extra base temperature without browning, e.g. pastry dishes, pizza. Also suitable for slow cooking of stews and casseroles.</p>	 <p>Circulaire: The combination of the fan and circular element around it gives a hot air cooking method. This provides many benefits including no preheat if cook time is more than 20 minutes, no flavour transfer when cooking different foods at the same time, less energy, and shorter cook times. Good for all types of food.</p>
 <p>ECO: The combination of the grill, fan and lower element is particularly suitable for cooking small quantities of food.</p>	 <p>Grill element: Using of grill gives excellent results when cooking meat of medium and small portions, especially when combined with a rotisserie (where possible). Also ideal for cooking sausages and bacon.</p>
 <p>Light</p>	 <p>All glass inner door: All glass inner door, a single flat surface which is simple to keep clean.</p>
 <p>The inner door glass: can be removed with a few quick movements for cleaning.</p>	 <p>Side lights: Two opposing side lights increase visibility inside the oven.</p>
 <p>The oven cavity has 2 different cooking levels.</p>	 <p>The oven cavity has 4 different cooking levels.</p>
 <p>Telescopic rails: allow you to pull out the dish and check it without having to remove it from the oven entirely.</p>	 <p>Electronic control: Allows you to maintain temperature inside the oven with the precision 2-3 ° C. This enables to cook meals that are very sensitive to temperature changes, such as cakes, souffles, puddings.</p>

- 
- |  |   |   |   |
|--|---|---|---|
|  | Tilting grill: the tilting grill can be easily unhooked to move the heating element and clean the roof of the appliance in one simple step. |  | Ultra rapid burners: Powerful ultra rapid burners offer up to 5kw of power.     |
|  | Vapour Clean: a simple cleaning function using steam to loosen deposits in the oven cavity.   |  | The capacity indicates the amount of usable space in the oven cavity in litres. |
|  | The capacity indicates the amount of usable space in the oven cavity in litres.   |  | Knobs control   |

## Benefit (TT)

---

### **Gas hob**

Gas provides constant control of the heat source, with an immediate change in temperature

Equipped with a thermocouple, the gas supply is cut off if the flame is extinguished for greater safety

### **Vapor Clean**

By inserting water into a recess at the bottom of the cavity, steam is generated, which softens the residue and facilitates its removal

By inserting water into a recess at the bottom of the cavity, steam is generated, which softens the residue and facilitates its removal.

### **Buttons control**

Easy and intuitive timer setting with a simple buttons

### **Drawer storage compartment**

More space thanks to the lower compartment, ideal for storing accessories or cooking utensils

### **True-convection**

The best cooking performances guaranteed by ventilated circular flow.

Multiple fans and heating elements guarantee the perfect aerodynamic heat flow, allowing homogeneous and quicker cooking inside the cavity.

### **Multilevel cooking**

Several cooking levels allow maximum flexibility of use

### **Multilevel halogen light**

Internal halogen lighting on different levels guarantees excellent visibility

### **Removable inner glass**

Internal door glasses are easily removable for complete cleaning

### **Tangential cooling**

New cooling system with tangential fan and airflow from the door to the splashback

### **Telescopic guides**

Easy extraction and safe insertion of trays into the oven thanks to telescopic guides

### **Adjustable height**

Cooker top flushed with the working area thanks to adjustable feet

### **Isothermic Cavity**

The best cooking performance at the highest energy efficiency

### **BBQ (optional accessory)**

Barbeque cooking directly in the oven with the double-sided grill

### **Pizza stone (optional accessory)**

Baking with refractory stone for soft and crispy pizza and yeast products (STONE optional accessory)

### **Cold door**

During any function, the external door glass is cold, avoiding any risk of burns

### **AirFry (AIRFRY optional accessory)**

Lighter and tastier food thanks to airfry basket