

# TRA90GPGR

Cooker size	90x60 cm
Hob type	Gas
Type of main oven	Thermoseal
Cleaning system main oven	Pyrolitic
EAN code	8017709345167











## Aesthetics



<b>Aesthetic</b>	Victoria	<b>Controls colour</b>	Stainless steel
<b>Design</b>	Victoria	<b>No. of controls</b>	8
<b>Colour</b>	Slate Grey	<b>Serigraphy colour</b>	Silver
<b>Finishing</b>	Glossy	<b>Display</b>	electronic 5 buttons
<b>Command panel finish</b>	Enamelled metal	<b>Door</b>	With frame
<b>Logo</b>	assembled 50's	<b>Glass type</b>	Black
<b>Logo position</b>	Upstand+ Command panel	<b>Handle</b>	Smeg Victoria
<b>Upstand</b>	Yes	<b>Handle Colour</b>	Polished chrome
<b>Hob colour</b>	Black enamel	<b>Storage compartment</b>	Push pull
<b>Type of pan stands</b>	Cast Iron	<b>Feet</b>	none
<b>Type of control setting</b>	Control knobs	<b>Plinth</b>	Black
<b>Control knobs</b>	Smeg Victoria		

## Programs / Functions

No. of cooking functions 9  
 Traditional cooking functions

 Static	 Fan assisted	 Circulaire
 Turbo	 Eco	 Small grill
 Large grill	 Fan grill (large)	 Fan assisted bottom

## Cleaning functions



Pyrolytic

## Hob technical features



**Total no. of cook zones** 5

Front left - Gas - Rapid - 2.90 kW

Rear left - Gas - Semi Rapid - 1.80 kW

Central - Gas - 2UR (dual) - 5.00 kW

Rear right - Gas - Semi Rapid - 1.80 kW

Front right - Gas - AUX - 1.00 kW

**Type of gas burners** Standard

**Gas safety valves** Yes

**Automatic electronic ignition** Yes

**Burner caps** Matt black enamelled

## Main Oven Technical Features



**No. of lights** 2

**Fan number** 2

**Net volume of the cavity** 115 l

**Gross volume, 1st cavity** 129 l

**Cavity material** Ever Clean enamel

**No. of shelves** 5

**Type of shelves** Metal racks

**Light type** Halogen

**Light Power** 40 W

**Cooking time setting** Start and Stop

**Light when oven door is open** Yes

**Door opening** Flap down

**Removable door** Yes

**Full glass inner door** Yes

**Removable inner door** Yes

**Total no. of door glasses** 4

**No. of thermo-reflective door glasses** 2

**Safety Thermostat** Yes

**Cooling system** Tangential

**Door Lock During Pyrolysis** Yes

**Usable cavity space dimensions (HxWxD)** 371x724x418 mm

**Temperature control** Electro-mechanical

**Lower heating element power** 1700 W

**Upper heating element - Power** 1200 W

**Grill element** 1700 W

**Large grill - Power** 2900 W

**Circular heating element - Power** 2 x 2000 W

**Grill type** Electric

**Soft Close system** Yes

## Options Main Oven

**Timer** Yes

**End of cooking acoustic alarm** Yes

**Minimum Temperature** 50 °C

**Maximum temperature** 280 °C

## Accessories included for Main Oven & Hob

Cast iron wok support	1	20mm deep tray	1
Moka stand in cast iron	1	40mm deep tray	1
Rack with back and side stop	1	Grill mesh	1

## Electrical Connection

Plug	(I) Australia	Type of electric cable installed	Yes, Single phase
Electrical connection rating	4200 W	Type of electric cable	Yes, Double and Three Phase
Current	18 A	Frequency	50 Hz
Voltage	220-240 V	Terminal block	5 poles
Voltage 2 (V)	380-415 V		

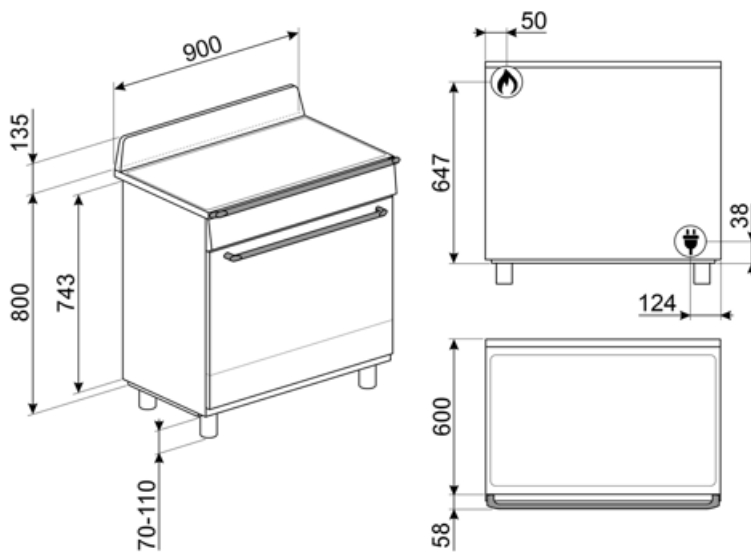

## Not included accessories

### AIRFRY9

Air fryer rack AIRFRY . Ideal for recreating traditional frying in the oven, but with fewer calories and less fat. It allows you to cook quickly and simply dishes such as French fries, fried vegetables and fish, ensuring perfect browning and crispiness.



### BBQ9



### BN920

### BN940

### GTP

\*\*Partially extractable telescopic guides (1 level)\*\* Extraction: 300 mm Material: Stainless steel AISI 430 polished



### GTT

\*\*Totally extractable telescopic guides (1 level)\*\* Extraction: 433 mm Material: Stainless steel AISI 430 polished



### KIT1TR9N

Splashback, 90x75 cm suitable for TR9 Victoria cookers, black



### PALPZ

Pizza shovel with fold away handle width: 315mm length : 325mm



### PPR9

Refractory pizza stone without handles. Squared shaped stone: L64xH2,3xP37,5 cm Suitable also for gas ovens, to be put on the griddle.



### SFLK1

Child lock







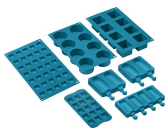











### SMOLD

Set of 7 silicone moulds for ice creams, ice lollies, pralines, ice cubes or to portion food. Usable from -60°C to +230°C



## Symbols glossary

 <p>Heavy duty cast iron pan stands: for maximum stability and strength.</p>	 <p>Air cooling system: to ensure a safe surface temperatures.</p>
 <p>Quadruple glazed: Number of glazed doors.</p>	 <p>Enamel interior: The enamel interior of all Smeg ovens have a special antacid lining which helps keep the interior clean by reducing the amount of cooking grease adhering to it.</p>
 <p>Fan assisted base: the mix of fan and lower heating element alone allows to finish cooking foods already cooked on the surface but not internally more quickly. This system is recommended to finish cooking foods that are already well cooked on the surface, but not internally, which therefore require a moderate higher heat. Ideal for any type of food.</p>	 <p>Fan with upper and lower elements: The elements combined with the fan aim to provide more uniform heat, a similar method to conventional cooking, so pre-heat is required. Most suitable for items requiring slow cooking methods.</p>
 <p>Upper and lower element only: a traditional cooking method best suited for single items located in the centre of the oven. the top pf the oven will always be hottest. Ideal for roast, fruit cakes, bread etc.</p>	 <p>Circulaire: The combination of the fan and circular element around it gives a hot air cooking method. This provides many benefits including no preheat if cook time is more than 20 minutes, no flavour transfer when cooking different foods at the same time, less energy, and shorter cook times. Good for all types of food.</p>
 <p>ECO: The combination of the grill, fan and lower element is particularly suitable for cooking small quantities of food.</p>	 <p>Grill element: Using of grill gives excellent results when cooking meat of medium and small portions, especially when combined with a rotisserie (where possible). Also ideal for cooking sausages and bacon.</p>
 <p>Half grill: For rapid cooking and browning of foods. Best results can be obtained by using the top shelf for small items, the lower shelves for larger ones, such as chops or sausages. For half grill heat is generated only at the centre of the element, so is ideal for smaller quantities.</p>	 <p>Fan with grill element: The fan reduces the fierce heat from the grill, providing an excellent method of grilling various foods, chops, steaks, sausages etc. giving even browning and heat distribution, without drying out the food. The top two levels recommended for use, and the lower part of the oven can be used to keep items warm at the same time, an excellent facility when cooking a grilled breakfast. Half grill (centre portion only) is ideal for small quantities of food.</p>
 <p>Circulaire with upper and lower elements: The use of the fan with both elements allows food to be cooked quickly and effectively, ideal for large joints that require thorough cooking. It offers a similar result to rotisserie, moving the heat around the food, instead of moving the food itself, enabling any size or shape to be cooked.</p>	 <p>All glass inner door: All glass inner door, a single flat surface which is simple to keep clean.</p>
 <p>The inner door glass: can be removed with a few quick movements for cleaning.</p>	 <p>Side lights: Two opposing side lights increase visibility inside the oven.</p>



Automatic opening: some models have Automatic opening door when the cycle is finished which is a perfect solution for handle-less kitchen units as no handle is needed. For safety reasons, the door locks automatically when the machine is in use to avoid it being opened inadvertently.



Pyrolitic: Pyrolitic cleaning cycles can be selected as necessary to automatically clean the oven interior.



The oven cavity has 5 different cooking levels.



Soft close: all models are equipped with advanced function of smooth closing of the door, which allows the device to close smoothly and quietly.



Ultra rapid burners: Powerful ultra rapid burners offer up to 5kw of power.



The capacity indicates the amount of usable space in the oven cavity in litres.



Knobs control

---

## Benefit (TT)

---

### **Gas hob**

Induction offers fast cooking and precise temperature control

Equipped with a thermocouple, the gas supply is cut off if the flame is extinguished for greater safety

### **Pyrolysis**

Easy oven cleaning thanks to special pyrolytic function

### **Buttons control**

Easy and intuitive timer setting with a simple buttons

### **Push-pull storage compartment**

More space thanks to the lower push-pull compartment, ideal for storing accessories or cooking utensils

### **True-convection**

The best cooking performances guaranteed by ventilated circular flow.

Multiple fans and heating elements guarantee the perfect aerodynamic heat flow, allowing homogeneous and quicker cooking inside the cavity.

### **Multilevel cooking**

Several cooking levels allow maximum flexibility of use

### **Multilevel halogen light**

Internal halogen lighting on different levels guarantees excellent visibility

### **Removable inner glass**

Internal door glasses are easily removable for complete cleaning

### **Tangential cooling**

New cooling system with tangential fan and airflow from the door to the splashback

### **Isothermic Cavity**

The best cooking performance at the highest energy efficiency

### **BBQ (optional accessory)**

Barbeque cooking directly in the oven with the double-sided grill

### **Pizza stone (optional accessory)**

Baking with refractory stone for soft and crispy pizza and yeast products (STONE optional accessory)

#### **Cold door**

During any function, the external door glass is cold, avoiding any risk of burns

#### **AirFry (AIRFRY optional accessory)**

Lighter and tastier food thanks to airfry basket

#### **Adjustable height**

Cooker top flushed with the working area thanks to adjustable feet

#### **Soft close**

The door is equipped with a specific system for silent closing

#### **Double Turbine**

The oven has two fans equipped with two circular heating elements allowing cooking with rotating heat