

A stainless steel finished, universal rangehood with Inter-locked push button Controls, 600mm in width, with a 3 speed single centrifugal fan.



Product Details

FEATURES

Auto thermal cutout safety switch

Optional carbon filter(s)

Washable filters

3 fan speeds

2 x filters

Push button controls

Front re-circulating option

Top and rear duct hole options

Two halogen lights

BENEFITS

Easy installation

The rangehood is easily installed either partially behind cupboard doors or simply under cabinetry.

Easy to clean

Removable filters for easy cleaning, and the rest of the rangehood is easy to maintain - simply wipe down.

Recirculation

The rangehood can recirculate into the kitchen if it is not possible to duct to the exterior. Carbon filters are recommended for recirculation.

Simple operation

Simple to use push button controls with 3 power settings to provide flexible air movement to manage diverse cooking demands.

Specifications

PRODUCT PROFILE

Domestic warranty details (yrs)	2
---------------------------------	---

Type of Rangehood	fixed
-------------------	-------

Nominal width (cm)	600
--------------------	-----

Finish of Rangehood	stainless steel
---------------------	-----------------

DIMENSIONS

Total product height (mm)	160
---------------------------	-----

Total product width (mm)	598
--------------------------	-----

Total product depth (mm)	500
--------------------------	-----

Diameter of ducting (mm)	120
--------------------------	-----

Minimum installation height from cooking surface Gas (mm)	650
---	-----

MOTOR/FAN

Number of fans	1
----------------	---

Number of fans speeds	3
-----------------------	---

Type of motor	centrifugal
---------------	-------------

Maximum airflow M3/Hr	200
-----------------------	-----

Noise level dB high	63
---------------------	----

Noise level dB low	51
--------------------	----

CONTROLS

Control panel	push button
---------------	-------------

DIMENSIONS

Minimum installation height from cooking surface Electric (mm) 600

FILTERS

Number of filters 2

Type of filter multilayer aluminum micromesh filters

Dishwasher safe Yes

DUCTING / RECIRCULATION

Ducting yes

Top or rear duct hole both

Recirculation option Yes

Recirculation kit optional accessory

Front recirculating option Yes

LIGHTS

Number of lights 2

Wattage of light 28

Type of light halogen

SHIPPING

Pack Dimensions Height (mm) 260

Pack Dimension Width (mm) 680

Pack Dimension Depth (mm) 590

Dimensions

Fixed rangehoods

WRF610SA/WA, WRF613SA/WA

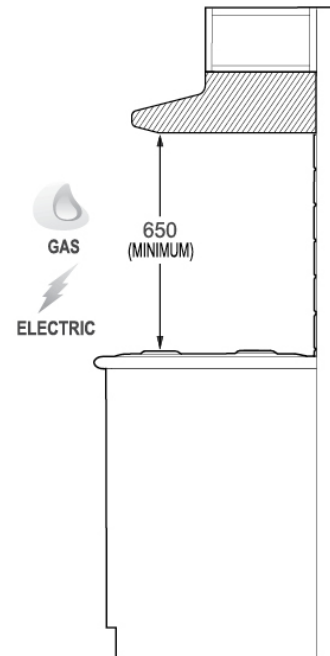
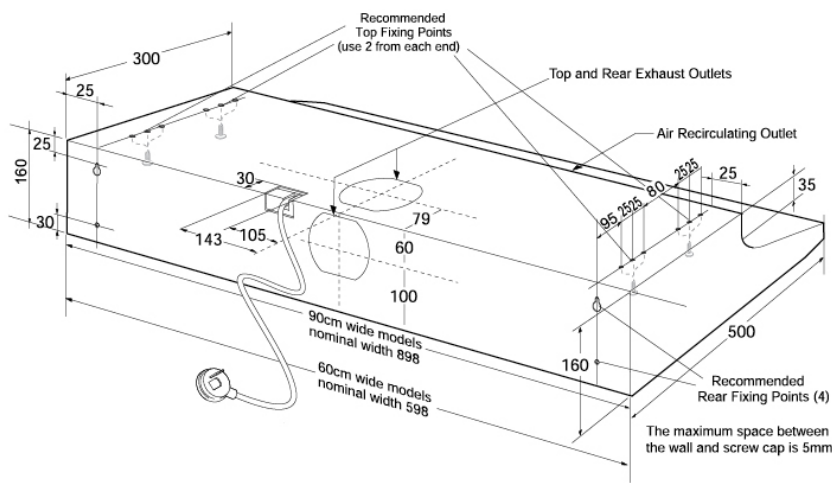

IMPORTANT

These dimensions are a guide only. All measurements are in millimetres (mm). For complete installation instructions, refer to the manual provided with product.

Terms and Conditions

IMPORTANT

This is a guide of product dimensions only. For complete installation instructions, refer to the manual provided with product.

PRODUCT INFORMATION

The descriptors and illustrations in this publication apply to the specific products and models described as at the date of issue. Under our policy of continuous product development, product specifications may change without notice. Prospective purchasers should therefore check with their retailer to ensure this publication correctly describes the products that are being offered for sale. All information supplied is to be used for general reference purposes only and is on the understanding that Electrolux Home Products Pty Ltd (Australia) and Electrolux (NZ) Ltd (New Zealand) will not be liable for any loss, liability or damage of whatever kind arising as a result of reliance on such information. Colours of products illustrated are as close as printing limitations allow. Electrolux will at all times comply with its obligations pursuant to law including Trade Practices (Australian Consumer Law) Act and Regulations.

WARRANTY

This warranty only applies to Appliances purchased and used in Australia or New Zealand and used in normal domestic applications and is in addition to (and does not exclude, restrict, or modify in any way) any non-excludable statutory warranties in Australia or New Zealand. All warranties are subject to the conditions set out in the warranty card accompanying the product when purchased.

ELECTROLUX HOME PRODUCTS AUSTRALIA

telephone: 1300 363 640

fax: 1800 350 067

email: customercare@electrolux.com.au

web: www.electrolux.com.au

ELECTROLUX HOME PRODUCTS NEW ZEALAND

telephone: 09 573 2230

fax: 09 573 2221

email: customercare@electrolux.co.nz

web: www.electrolux.co.nz